

Getting to Know Your Sound System

Make note of the location of the speakers and ceiling sensor in your classroom. Ensure that you have unpacked and charged your battery-powered microphones. Keep this guide handy for future reference.

Please note that some amplifier/receiver controls will differ. Refer to their markings, user manual, or our teachlogic.com for more information on their function.

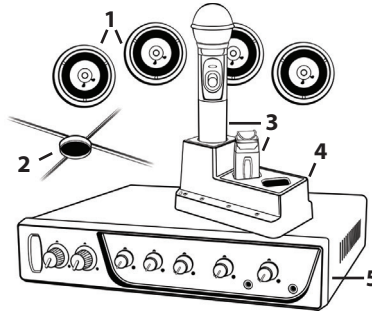

1. Speakers
2. Ceiling Sensor
3. Wireless Microphones
4. Microphone battery charger
5. Receiver/Amplifier

STEP 1. USING THE AMPLIFIER/RECEIVER

1. Power & Status Indicator

- Red: OFF
- Blue: ON and activated
- Amber: STANDBY

2. Mic Channels/Volume Controls

- Green light: Microphone on and connected to channel
- No light: Microphone is not on; and/or sensor is not plugged in; and/or sensor is not receiving mic signal

3. Input Volume Controls

- Controls volume of connected external devices

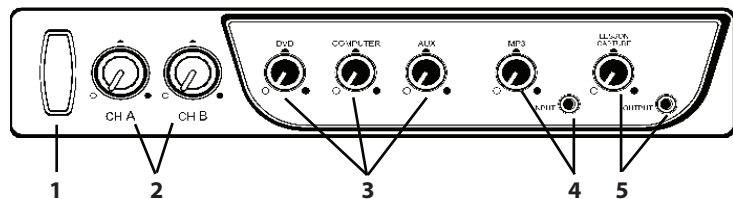

4. Input Jack and Volume Control

- Connects additional external devices to the system (ex. iPhone or mp3 player)

5. Output Volume Control and Output Jack

- Connects devices for recording lessons

STEP 2. USING THE SAPPHIRE™ PENDANT MICROPHONE

1. Power button and status indicator

- Solid Red: OFF
- Solid Blue: ON
- Solid Purple: External devices quieted

- 2. Mute microphone:** Briefly press power button once (flashing blue).
Unmute microphone: Briefly press power button again (solid blue).

- 3. Aux Input:** Connects devices (like music player) to microphone.

4. Priority Switch:

- Changes volume of devices plugged into amp inputs
- To increase/decrease volume level: Slide button up or down
- To immediately quiet volume level of external device: Push button once
- To resume volume level of external device: Push button again

5. Activate Security Alert Feature (when available)

- Hold Priority Switch down for 5 seconds. The power light on the amp will flash green, then return to solid blue.

6. Gain Switch

- There are 3 levels to adjust your microphone volume.
- Set gain at "Normal". You may reduce the volume by setting it to -3dB or -6dB if your mic is too loud.

7. Lanyard attachments

- Microphone should rest where your collar bones meet.

8. USB Charge Port (found on the bottom of the mic)

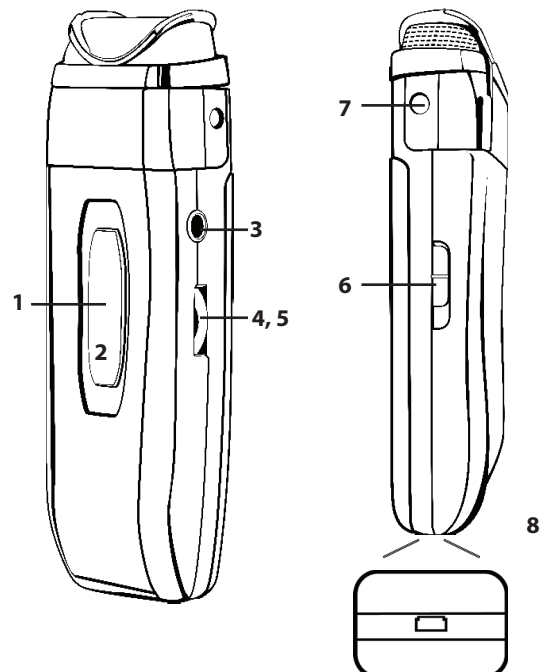

STEP 3. USING THE HANDHELD MICROPHONE

1. ON/OFF switch

2. Battery Level Indicator

- Green: Charged
- Red: Low battery
- Flashing Red: Wrong batteries installed or batteries need replacement

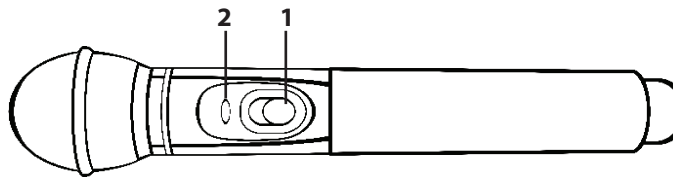

STEP 4. SETTING UP THE MICROPHONES

1. Activate the amp by pushing the power button. The "TL" on the button should be illuminated blue.

2. Set the CH A and CH B volume controls to the far counter clockwise position.

3. **Sapphire Mic:** Connect the lanyard and place around your neck so the mic sits between your collar bones. Set the gain switch to "Normal" position.

4. Turn "ON" the Sapphire via the front switch; push and hold for three seconds.

5. On the amp, check to confirm that the LED next to CH A volume control is illuminated green, indicating IR signal is being received.

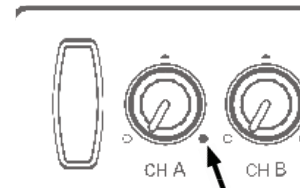
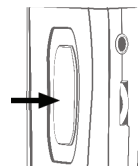
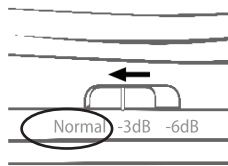
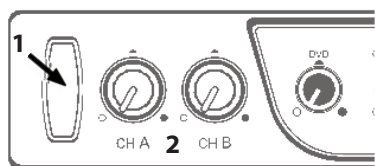

6. Locate yourself directly under a ceiling speaker.

7. While speaking into the mic, have someone else slowly increase the volume of CH A. When you begin to hear a ringing sound (feedback) decrease volume until it disappears. This is your mic volume setting.

8. While talking, walk around the room to ensure you have reception without feedback.

9. **Handheld Mic:** Repeat this process using CH B to set the volume.

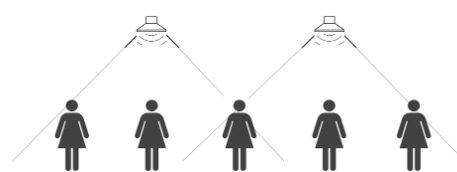
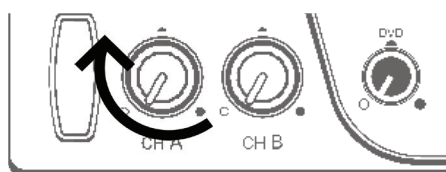
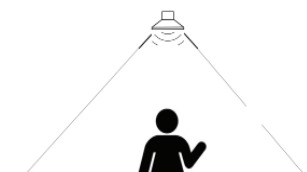

STEP 5. CHARGING THE MICROPHONES

Charger Status Indicator

- Blue: ON
- Red: Battery charging
- Green: Charging complete

- Ensure your microphone is fully charged before its initial use.
- Charging takes approx 6-8 hrs.
- Battery typically lasts 8-10 hrs.

WHEN REPLACING BATTERIES IN THE HANDHELD MIC, ALWAYS REPLACE IN PAIRS. ONLY USE RECHARGEABLE BATTERIES!

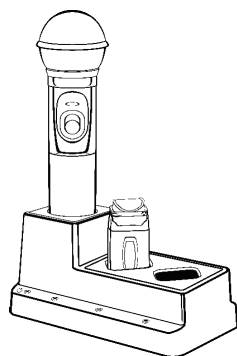

Do not force mics into the cradle. Ensure that both the charger and Sapphire are aligned in the same direction facing front as shown.

STEP 7. TROUBLESHOOTING

1. System is turned on but there is no LED indicator light

- Check if system has been unplugged.
- Verify that electrical outlet is generating power.

2. System has power (LED indicator blue) but no sound

- Make sure microphone is on.
- Ensure the mic signal indicator light is illuminated green.
- Ensure ceiling sensor LED is green. If not, the sensor is not receiving power.

3. Voice is distorted or sound drops

- Ensure there's nothing between the mic and ceiling sensor (mics will not work if placed in pockets, for example).
- Battery charge level may be low. Charge and retest.

4. Hum is heard w/computer plugged into Comp/Aux input

- Locate the "COMP ANTI-HUM" switch on the back panel of the amp and slide to "ON".

5. Receiver does not "wake up" from standby

- Volume of external device too low when played
- Microphone not on or not working properly